

1 000 to 1 600 nm OPTICAL FIBER COMMUNICATIONS  
 $\phi 80 \mu\text{m}$  InGaAs PIN PHOTO DIODE MODULE

**DESCRIPTION**

NDL5461P Series is InGaAs PIN photo diode modules with multimode fiber. They are designed for long wavelength transmission systems and cover the wavelength range between 1 000 and 1 600 nm with high efficiency.

**FEATURES**

- Smaller dark current  $I_D = 0.1 \text{ nA}$
- High quantum efficiency  $\eta = 86 \% @ \lambda = 1\,300 \text{ nm}$   
 $\eta = 75 \% @ \lambda = 1\,550 \text{ nm}$
- Detecting area size  $\phi 80 \mu\text{m}$
- Low operating voltage  $V_R = 5 \text{ V}$
- Coaxial module with multimode fiber (GI-50/125) or optional singlemode fiber (SM-9/125)
- NDL5461P1 and NDL5461P2 have a flange.

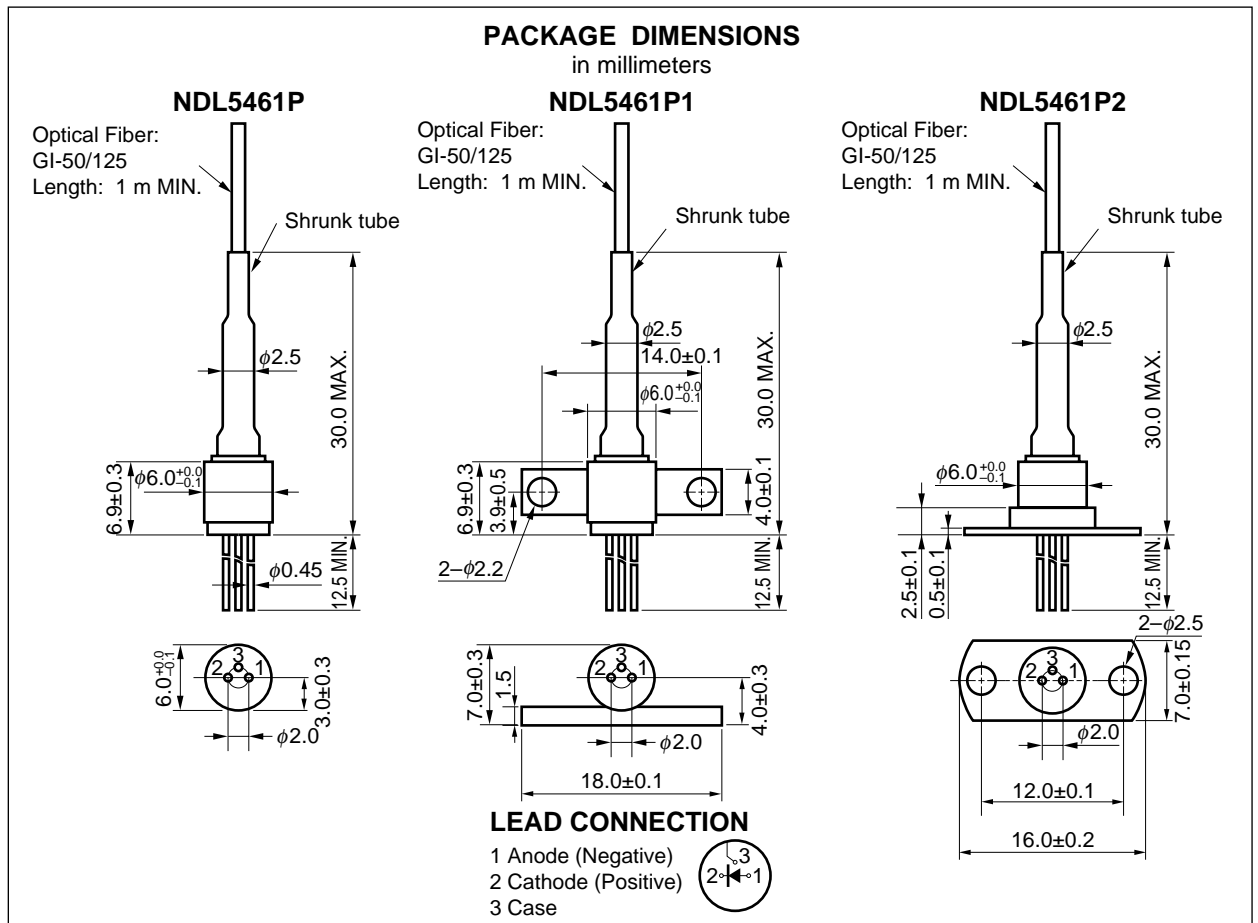

The information in this document is subject to change without notice.

★ ORDERING INFORMATION

Part Number	Available Connector		
NDL5461P	Without Connector	GI-50/125	no flange
NDL5461PC	With FC-PC Connector		
NDL5461PD	With SC-PC Connector		
NDL5461PS	Without Connector	SM-9/125	
NDL5461PSC	With FC-PC Connector		
NDL5461PSD	With SC-PC Connector		
NDL5461P1	Without Connector	GI-50/125	flat mount flange
NDL5461P1C	With FC-PC Connector		
NDL5461P1D	With SC-PC Connector		
NDL5461P1S	Without Connector	SM-9/125	
NDL5461P1SC	With FC-PC Connector		
NDL5461P1SD	With SC-PC Connector		
NDL5461P2	Without Connector	GI-50/125	vertical flange
NDL5461P2C	With FC-PC Connector		
NDL5461P2D	With SC-PC Connector		
NDL5461P2S	Without Connector	SM-9/125	
NDL5461P2SC	With FC-PC Connector		
NDL5461P2SD	With SC-PC Connector		

ABSOLUTE MAXIMUM RATINGS (T<sub>c</sub> = 25 °C)

Parameter	Symbol	Ratings	Unit
Reverse Voltage	V <sub>R</sub>	20	V
Forward Current	I <sub>F</sub>	10	mA
Optical Input Power	P <sub>in</sub>	8	mW
Operating Case Temperature	T <sub>c</sub>	-40 to +85	°C
Storage Temperature	T <sub>stg</sub>	-40 to +85	°C

ELECTRO-OPTICAL CHARACTERISTICS (T<sub>c</sub> = 25 °C)

Parameter	Symbol	Conditions	MIN.	TYP.	MAX.	Unit
Dark Current	I <sub>D</sub>	V <sub>R</sub> = 5 V		0.1	1.0	nA
Terminal Capacitance	C <sub>t</sub>	V <sub>R</sub> = 5 V, f = 1.0 MHz		1.0	1.5	pF
Quantum Efficiency	η	λ = 1 300 nm	75	86		%
		λ = 1 550 nm	64	75		
Responsivity	S	λ = 1 300 nm	0.78	0.89		A/W
		λ = 1 550 nm	0.80	0.94		
Cut-off Frequency	f <sub>c</sub>	V <sub>R</sub> = 5 V, R <sub>L</sub> = 50 Ω, λ = 1 300 nm	2.5			GHz

TYPICAL CHARACTERISTICS

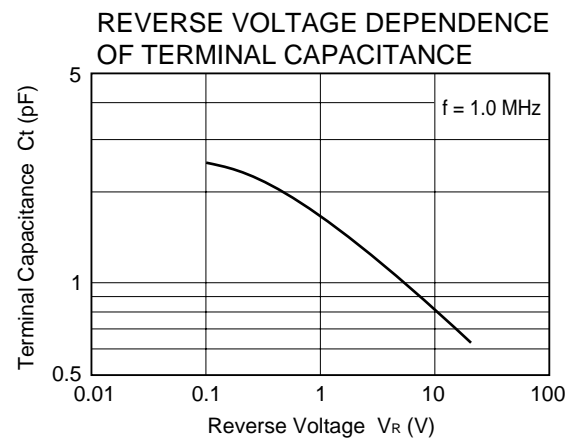
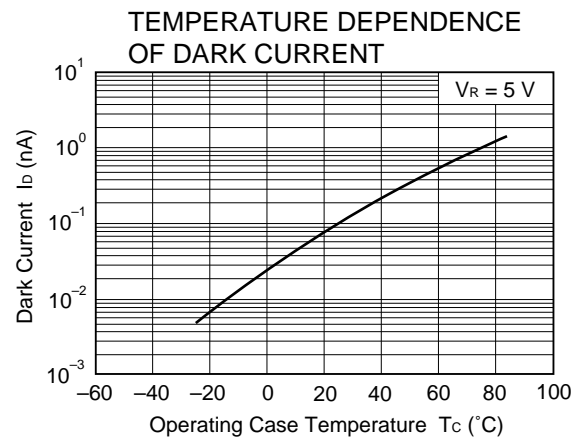
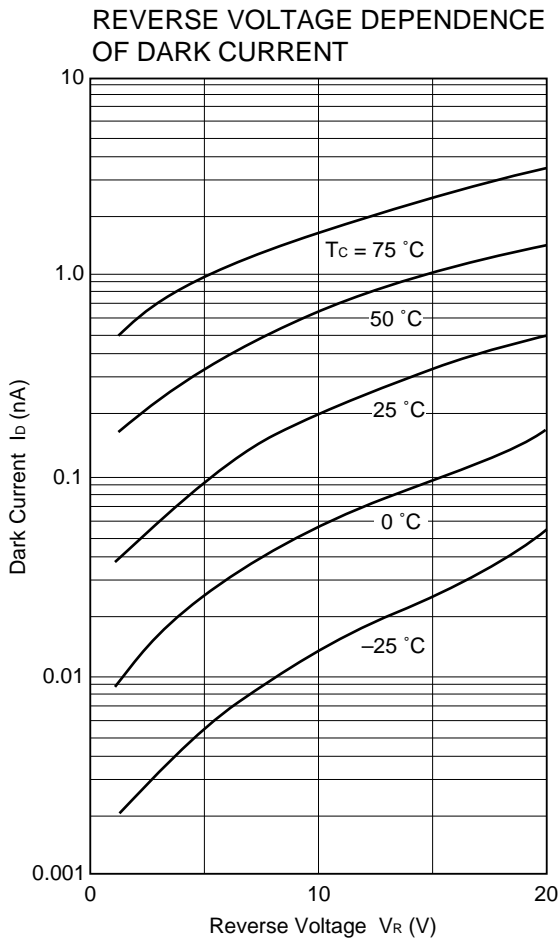
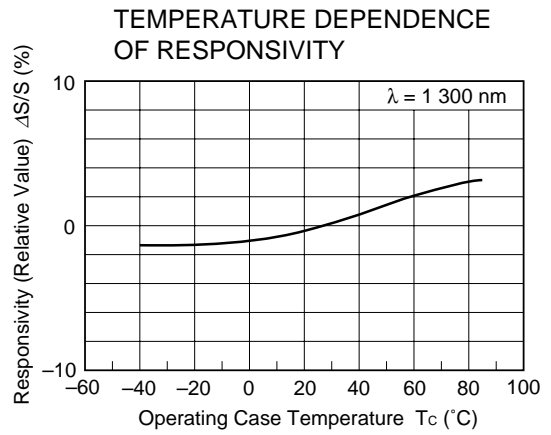
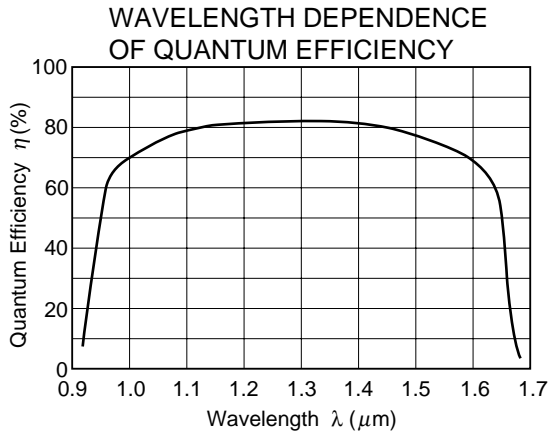

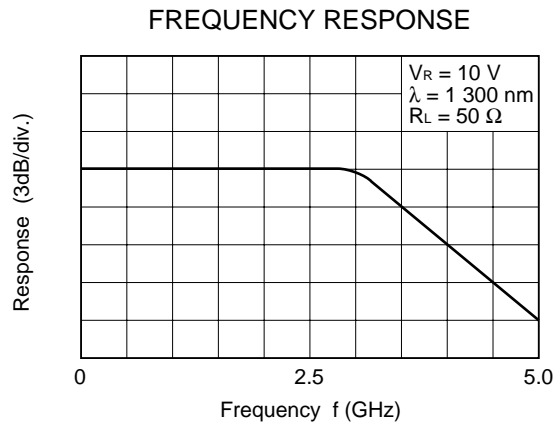

**HANDLING PRECAUTION for PD/APD MODULE**



The NEC PD/APD module has heat shrink tubing to protect the ferrule edge (\*1) and the junction between the ferrule and the module body (\*2). In order to avoid breaking the fiber and/or optical coupling degradation, NEC recommends the following handling precautions.

1. Do not make the fiber bend radius less than 30 mm (\*3).
2. Do not bend the fiber within the 18 mm section from the module body (\*4).
3. Do not stress the ferrule with a lateral force exceeding 500 g (\*5).

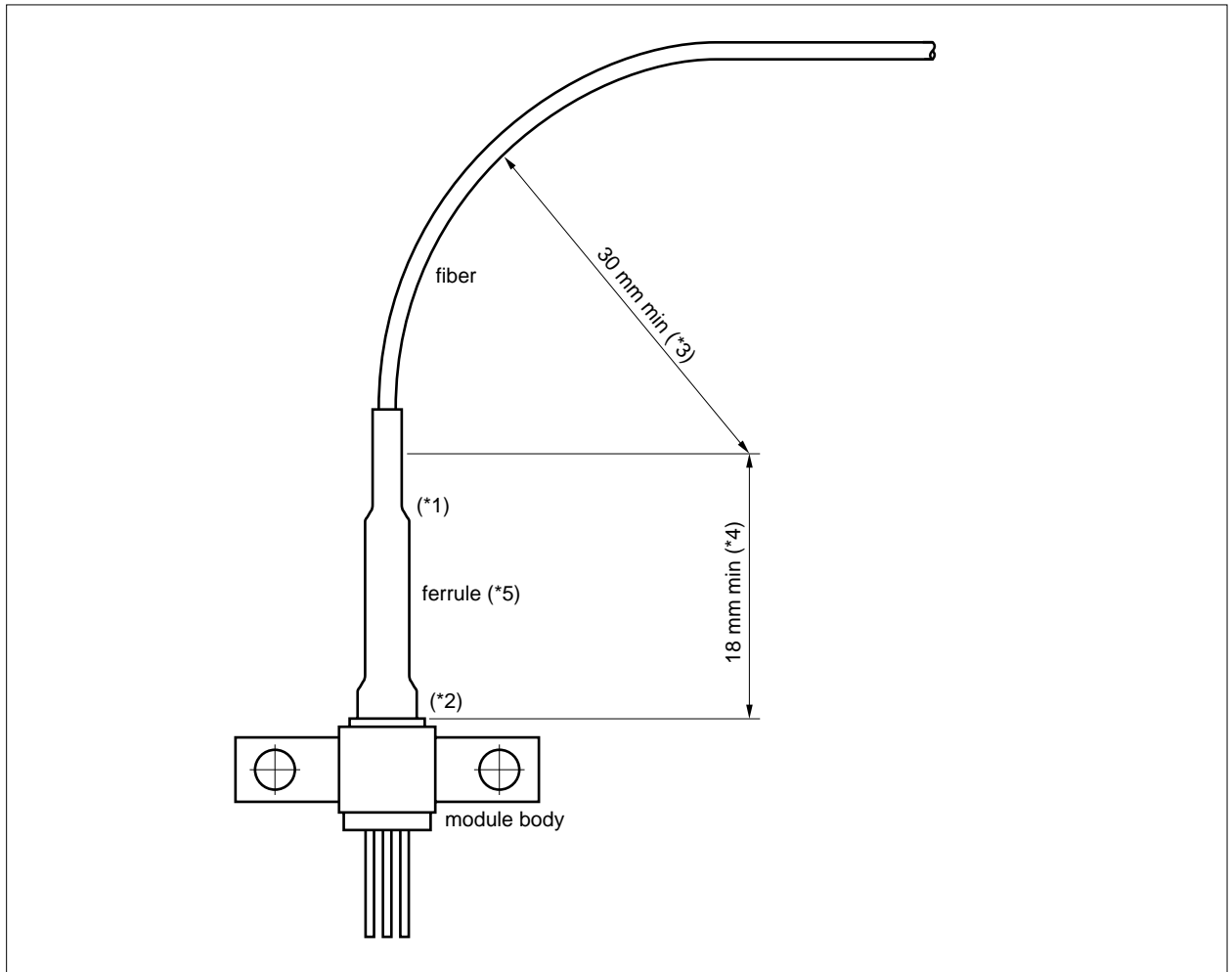

★ InGaAs APD/PD FAMILY

Features Packages	APD				PIN-PD		Remarks
	φ30 μm (for 2.5 Gb/s)	φ50 μm (for 2.5 Gb/s)	φ50 μm	φ80 μm	φ50 μm (for 2.5 Gb/s)	φ80 μm	
TO-18 type Can	NDL5530	_____	NDL5500	NDL5510	_____	_____	3 pins
TO-18 type Can with Micro Lens	_____	_____	_____	_____	NDL5490L <sup>*3,4</sup>	NDL5405L	3 pins
Small Can φ5.6 μm	NDL5531	_____	_____	_____	NDL5490 <sup>*3,4</sup>	_____	
Chip on Carrier	NDL5530C	NDL5520C	NDL5500C	NDL5510C	_____	_____	
Receptacle Module	_____	_____	_____	_____	_____	NDL5471RC NDL5471RD	3 pins RC: FC receptacle RD: SC receptacle
Coaxial Module with MMF	_____	NDL5521P NDL5521P1 NDL5521P2	NDL5551P NDL5551P1 NDL5551P2 NDL5553P <sup>*1</sup> NDL5553P1 <sup>*1</sup> NDL5553P2 <sup>*1</sup>	NDL5561P <sup>*2</sup> NDL5561P1 <sup>*2</sup> NDL5561P2 <sup>*2</sup>	_____	NDL5461P NDL5461P1 NDL5461P2	P1, P2: With flange
Coaxial Module with SMF	_____	_____	NDL5553PS <sup>*1</sup> NDL5553P1S <sup>*1</sup> NDL5553P2S <sup>*1</sup>	_____	_____	NDL5481P <sup>*5</sup> NDL5481P1 <sup>*5</sup> NDL5481P2 <sup>*5</sup>	
14-pin DIP Module with TEC	_____	_____	NDL5506P NDL5506PS	_____	_____	_____	ΔT = 45 K (@ I <sub>c</sub> = 1.1 A) PS: With SMF
6-pin BFY Module with MMF	_____	NDL5522P	_____	_____	NDL5422P	_____	With Pre-AMP

\*1 For OTDR

\*2 With GI-62.5/125

\*3 Under development

\*4 Internal pre-amplifier for 1Gb/s

\*5 For analog application (optical CATV)

**Remark** Modules are available with FC-PC connector or optional SC-PC connector.

**REFERENCE**

Document Name	Document No.
NEC semiconductor device reliability/quality control system	IEI-1205
Quality grade on NEC semiconductor devices	IEI-1209
Semiconductor device mounting technology manual	C10535E
Semiconductor device package manual	IEI-1213
Guide to quality assurance for semiconductor devices	MEI-1202
Semiconductor selection guide	X10679E

**CAUTION**

**Within this device there exists GaAs (Gallium Arsenide) material which is a harmful substance if ingested. Please do not under any circumstance break the hermetic seal.**

The export of this product from Japan is prohibited without governmental license. To export or re-export this product from a country other than Japan may also be prohibited without a license from that country. Please call an NEC sales representative.

No part of this document may be copied or reproduced in any form or by any means without the prior written consent of NEC Corporation. NEC Corporation assumes no responsibility for any errors which may appear in this document.

NEC Corporation does not assume any liability for infringement of patents, copyrights or other intellectual property rights of third parties by or arising from use of a device described herein or any other liability arising from use of such device. No license, either express, implied or otherwise, is granted under any patents, copyrights or other intellectual property rights of NEC Corporation or others.

While NEC Corporation has been making continuous effort to enhance the reliability of its semiconductor devices, the possibility of defects cannot be eliminated entirely. To minimize risks of damage or injury to persons or property arising from a defect in an NEC semiconductor device, customer must incorporate sufficient safety measures in its design, such as redundancy, fire-containment, and anti-failure features.

NEC devices are classified into the following three quality grades:

"Standard", "Special", and "Specific". The Specific quality grade applies only to devices developed based on a customer designated "quality assurance program" for a specific application. The recommended applications of a device depend on its quality grade, as indicated below. Customers must check the quality grade of each device before using it in a particular application.

Standard: Computers, office equipment, communications equipment, test and measurement equipment, audio and visual equipment, home electronic appliances, machine tools, personal electronic equipment and industrial robots

Special: Transportation equipment (automobiles, trains, ships, etc.), traffic control systems, anti-disaster systems, anti-crime systems, safety equipment and medical equipment (not specifically designed for life support)

Specific: Aircrafts, aerospace equipment, submersible repeaters, nuclear reactor control systems, life support systems or medical equipment for life support, etc.

The quality grade of NEC devices in "Standard" unless otherwise specified in NEC's Data Sheets or Data Books. If customers intend to use NEC devices for applications other than those specified for Standard quality grade, they should contact NEC Sales Representative in advance.

Anti-radioactive design is not implemented in this product.